

Kabelbaumstecker
5-polig
 CPA offen
 Sekundärverriegelung offen

FEMALE CONNECTOR
5-WAY
 CPA OPEN
 SECONDARY LOCKING OPEN

© THIS DRAWING IS THE EXCLUSIVE PROPERTY OF
 ROBERT BOSCH GMBH; WITHOUT THEIR CONSENT IT MAY
 NOT BE REPRODUCED OR GIVEN TO THIRD PARTIES.

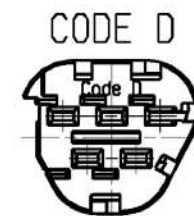
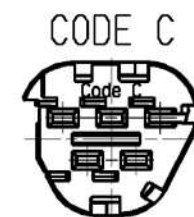
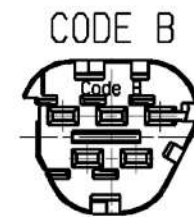
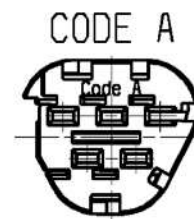
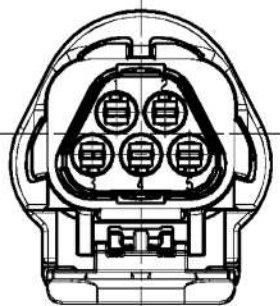
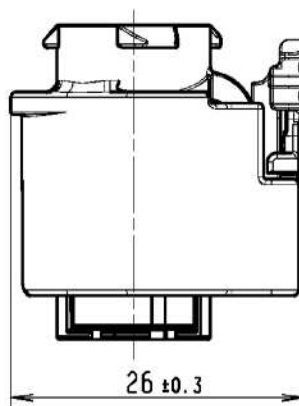
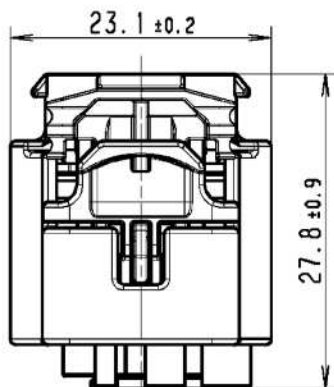
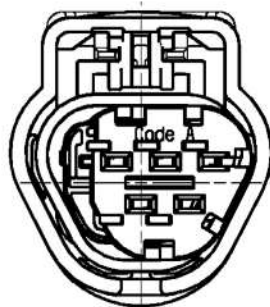

© Alle Rechte bei ROBERT BOSCH GMBH, auch für den
 Fall von Schutzrechtsanmeldungen. Jede Verfügungs-
 befugnis, wie Kopier- und Weitergaberecht, bei uns

Mit Standard-Dichtung: VMQ / WITH STANDARD SEAL: VMQ

	CODE A	CODE B	CODE C	CODE D
Farbe der Sekundärverriegelung / COLOR OF SECONDARY LOCKING	violett / VIOLET	blau / BLUE	rot / RED	grau / GREY
Farbe der Standard-Dichtung / COLOR OF STANDARD SEAL	gelb / YELLOW			
Bestell-Nr. / ORDER-NO.	1 928 405 138	1 928 405 159		

Weitere Informationen zur Steckverbindung: siehe Seite 13 - 18
 FURTHER INFORMATION TO THE PLUG CONNECTION: SEE PAGE 13 - 18

Angebotszeichnung OFFER DRAWING

14	Überarbeitung	Sit4kor	10.07.2015	Sa	BOSCH	Nr. / NO.	1 928 A00 152	de/en	Blatt / SHEET 11
Nr. NO	Änderung MODIFICATION	gez SIGN	gültig VALID	gepr. CHE					Bl./ 19