

Circular Connectors C 091 A Female receptacle front mounting, No. of contacts 6, 300 V

Part No. T 3403 000



Series Circular Connectors C091
Subseries Circular Connector C 091 A

View represents all available contact positions.

COMMON CHARACTERISTICS		
No. of contacts		6
Contact arrangement (DIN)	DIN EN 60130-9	45 322
Contact arrangement (IEC)	IEC 60130-9	60130-9
Assembly method		front mounting
ELECTRICAL CHARACTERISTICS		
Rated voltage	DIN EN 60664-1 / IEC 60664-1	300V
Rated voltage	UL 1977	250V
Rated impulse voltage	DIN EN 60664-1 / IEC 60664-1	1500V
Installation category	DIN EN 60664-1 / IEC 60664-1	I
Insulation group	DIN EN 60664-1 / IEC 60664-1	II, 400 ≤ CTI < 600
Insulation resistance	DIN EN 60512-2, Test 3a / IEC 60512-2, Test 3a	> 10 ¹⁰
Contact resistance	DIN EN 60512-2, Test 2a / IEC 60512-2 Test 2a	< 5 m
Pollution degree	DIN EN 60664-1 / IEC 60664-1	1
CLIMATICAL CHARACTERISTICS		
Climatic category	DIN EN 60068-1 / IEC 60068-1	40 / 100 / 56
Temperature range		-40 °C ... +100 °C-40 °F ... +212 °F
MECHANICAL CHARACTERISTICS		
IP degree of protection	DIN EN 60529 / IEC 60529	IP 40
Insertion and withdrawal force	DIN EN 60512-13-2, Test 13b / IEC 60512-13-2, Test 13b	50 N 180.oz
Mechanical lifetime		≥ 500 mating cycles
MATERIALS		
Insert		Thermoplastic
Contact plating		silver plated
Housing		die cast, nickel plated
FURTHER CHARACTERISTICS		
Termination		solder
Wire gauge		≤ 0,5 mm ²
Wire gauge (AWG)		≤ 20
Flammability	UL 94	UL 94 V0
Locking		screw

Circular Connectors C 091 A Female receptacle front mounting, No. of contacts 6, 300 V

Part No. T 3403 000

Series Circular Connectors C091

Subseries Circular Connector C 091 A



View represents all available contact positions.

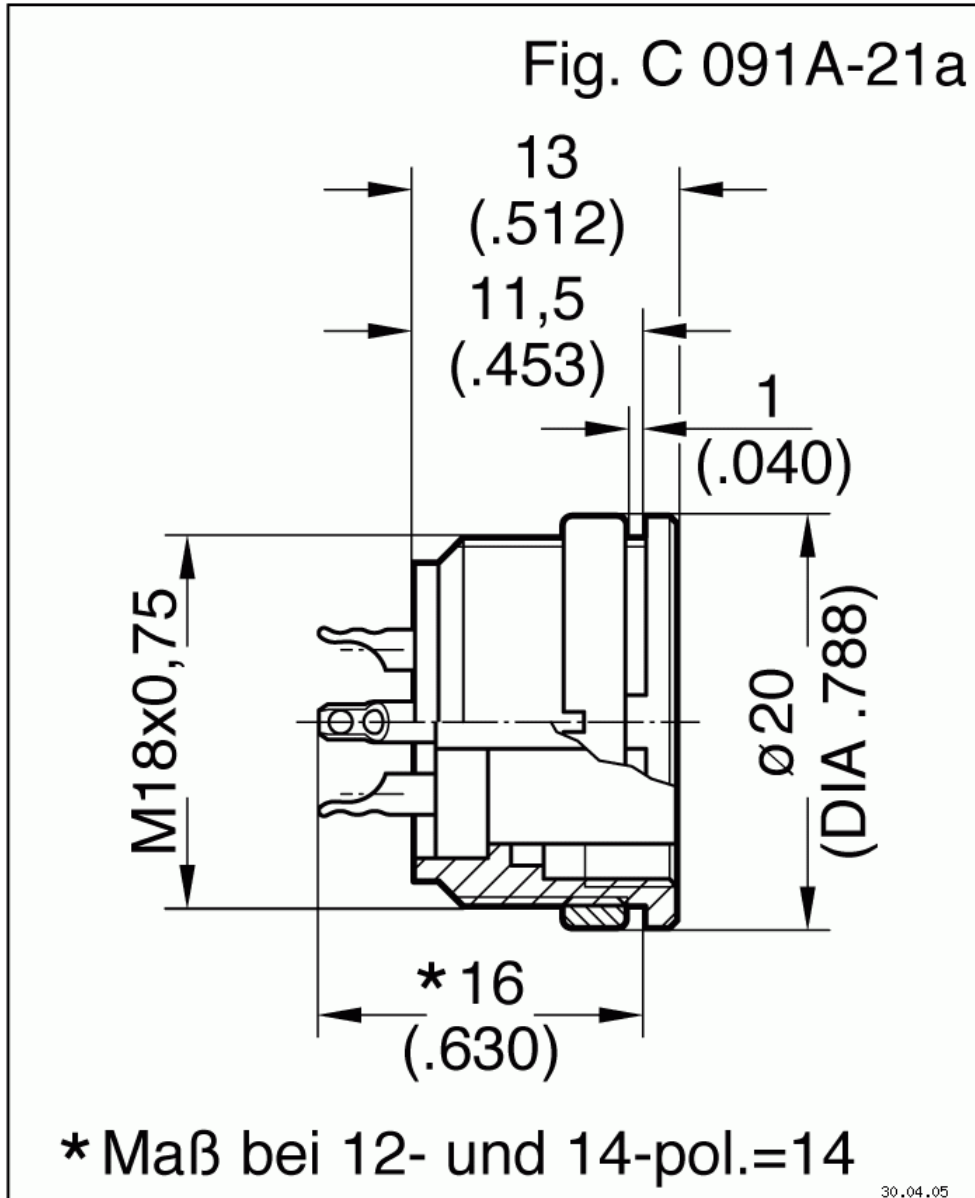

Drawing Dimensions in mm (Inch)

30.04.05

Circular Connectors C 091 A Female receptacle front mounting, No. of contacts 6, 300 V

Part No. T 3403 000

Series Circular Connectors C091

Subseries Circular Connector C 091 A



View represents all available contact positions.

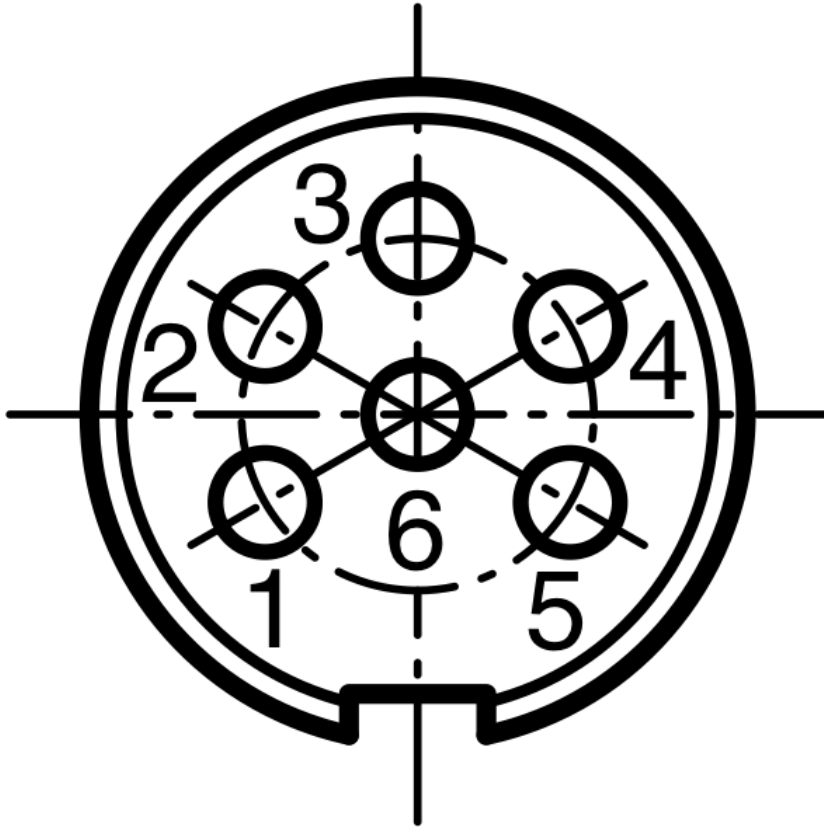

Contact arrangement